

# Lloyd — Jean-Marie Massaud — 2016/2022



Jean-Marie Massaud progetta Lloyd, sistema di contenitori e librerie a geometria variabile. Sottili bacchette di legno verticali formano griglie leggere, che scorrono per tutta la lunghezza su invisibili binari orizzontali. Ogni griglia è spostabile a piacere per creare sequenze sempre diverse. Una partitura cangiante di pieni e vuoti, di luci e ombre.

## CARATTERISTICHE TECNICHE

**Ripiani.** Realizzati in stratificato HPL impiallacciato in rovere naturale finitura piombo opaco (57).

**Montanti verticali.** Realizzati in fibra di legno a media densità rivestiti in cuoio:  
- Saddle  
- Saddle Extra  
Cuoio con bordo a taglio netto rifinito con tinta protettiva in colore abbinato.

**Fianchi.** Sono chiusi da griglie fisse realizzate in massello di rovere.

**Griglie scorrevoli.** In massello di rovere, si muovono lungo binari intagliati nei ripiani e sono dotate di “pattini” in materiale plastico che diminuiscono l’attrito.

### Varianti disponibili.

- “Freestanding”: presenta griglie scorrevoli su entrambi i lati (frontale e posteriore).
- “Wall”: presenta griglie scorrevoli solo sul lato frontale mentre il lato posteriore, a contatto con il muro, è chiuso da un pannello in MDF verniciato nero opaco che, sul lato interno (fondo) può essere rivestito in cuoio.

### Fondo (solo varianti “Wall”).

- Verniciato nero opaco
- Rivestito in cuoio

**Dettagli tecnici ed estetici.** Ogni griglia è un minuzioso lavoro di ebanisteria. Le bacchette sono intagliate in spessori diversi e poi incollate a mano una a una. Anche la tintura su di esse applicata, date le superfici ridotte, viene eseguita artigianalmente in più passaggi.

**Portata massima.** Non oltre i 15 Kg per ogni singolo vano.

## MODELLI LOW CABINET E BOOKCASE

**Piedi.** Realizzati in acciaio. Quelli esterni e in primo piano sono verniciati canna di fucile opaco mentre quelli centrali, più arretrati, sono laccati nero opaco.

## MODELLI HIGH CABINET (Novità 2022)

**Base a cavalletto.** In massello di rovere finitura piombo opaco (57).

## ACCESSORI E OPTIONAL

**Passaggio cavi opzionale.** Nelle varianti “Wall” dei modelli Low Cabinet è possibile richiedere la predisposizione per il passaggio dei cavi.

Jean-Marie Massaud has designed Lloyd, a system of storage units and bookcases, with variable geometries. A series of thin vertical wooden rods form light grids that run from top to bottom on invisible horizontal guides. Each grid can be moved as desired creating different sequences each time. A fluctuating score of solids and voids, of light and shade.

## TECHNICAL FEATURES

**Shelves.** Made of high pressure laminate in a natural oak veneer with a lead matte finish (57).

**Vertical uprights.** Made of MDF and covered with:  
- Saddle leather  
- Saddle Extra leather  
Saddle-leather features clean-cut edges with a protective tone-on-tone finish.

**Sides.** They are closed by fixed grids made of solid oak wood.

**Movable grids.** Made of solid oak wood, they slide along guides carved on the shelves. The grids feature plastic glides which reduce friction between the surfaces.

### Available versions.

- “Freestanding”: it features movable grids on both front and rear side.
- “Wall”: it features movable grids only on the front side. The rear side, in contact with the wall, is closed by a matt black stained MDF panel which can also be covered with saddle-leather on the internal visible side (bottom).

### Bottom (only for the “Wall” versions).

- Matt black finish
- Covered with saddle-leather

**Technical and aesthetic details.** Each grid is a meticulous phase of fine woodworking. The solid oak rods are cut in different thicknesses and then individually glued by hand. Also, on the thin surfaces of the rods, the lead-coloured dye is applied by hand in several phases.

**Maximum load.** The weight must not exceed 15kg for each compartment.

## LOW CABINETS AND BOOKCASES

**Feet.** Made of steel, the external front feet feature a gunmetal grey matt finish while the central one, placed behind, are matt black lacquered.

## HIGH CABINETS (2022 New products)

**Trestle-shaped base.** Solid oak wood with a lead matte finish (57).

## OPTIONAL ACCESSORIES

**Optional cable management system.** It is possible to fit the Low Cabinet “Wall” version with internal openings to run cables.

**Ripiano opzionale.** Autoportante e facilmente spostabile, è realizzato in alluminio e rivestito in cuoio con bordi tagliati a vivo e rifiniti con tinta abbinata e cera protettiva.

**Optional shelf.** Freestanding and easily movable, it is made of aluminium and covered with saddle-leather. The clean-cut edges are dyed and finished with protective wax.

**Griglie scorrevoli.** Disponibili in due differenti altezze: 20,5 cm e 36,5 cm.

**Movable grids.** Available in two different heights: 20,5 cm and 36,5 cm.

## LLOYD - LOW CABINETS

5607700

Freestanding

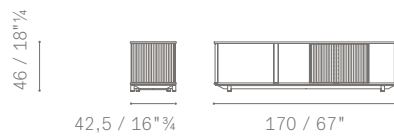

5607710

Wall

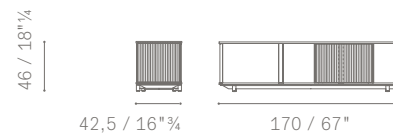

5607701

Freestanding

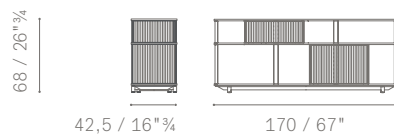

5607711

Wall

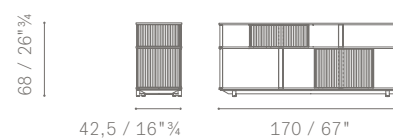

5607780

Freestanding

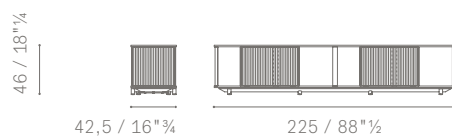

5607790

Wall

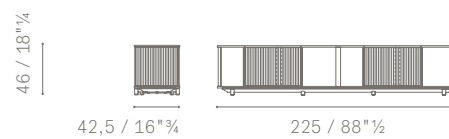

5607781

Freestanding

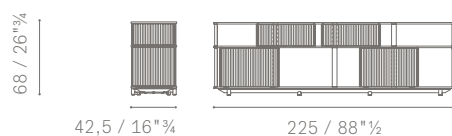

5607791

Wall

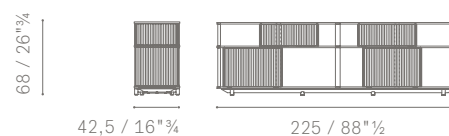

## LLOYD - LOW CABINETS

5607782  
Freestanding

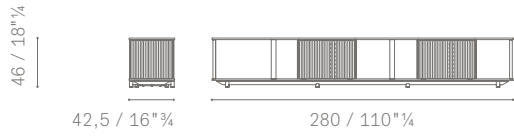

5607792  
Wall

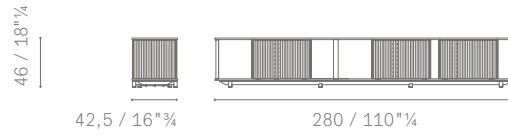

5607783  
Freestanding

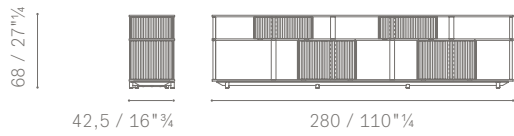

5607793  
Wall

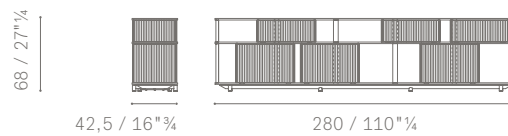

## LLOYD - HIGH CABINETS

5607720  
Freestanding

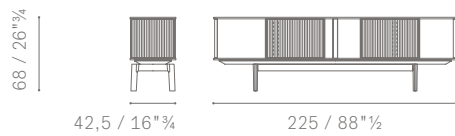

5607730  
Wall

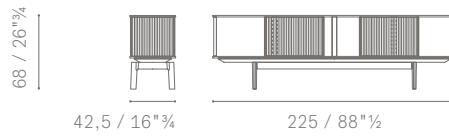

5607721  
Freestanding

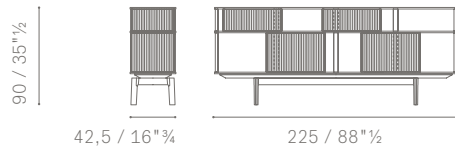

5607731  
Wall

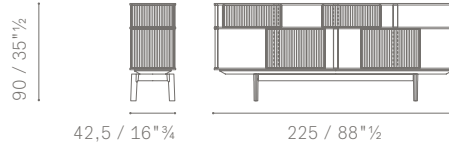

5607722  
Freestanding

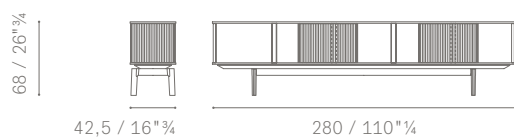

5607732  
Wall

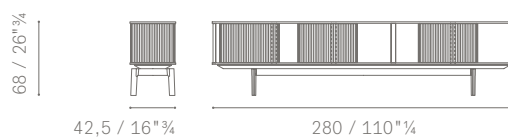

## LLOYD - HIGH CABINETS

5607723

Freestanding

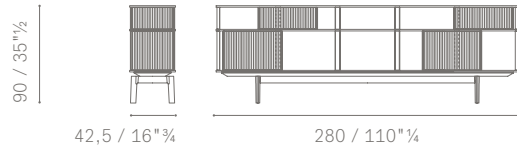

42,5 / 16"¾

280 / 110"¼

5607733

Wall

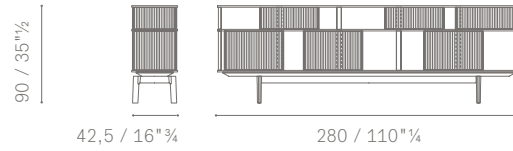

42,5 / 16"¾

280 / 110"¼

## LLOYD FULL - BOOKCASES

5607740

Freestanding

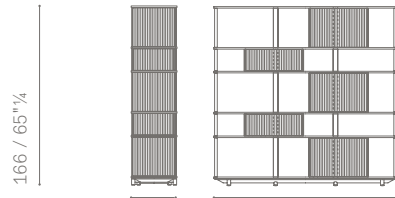

42,5 / 16"¾

170 / 67"

5607750

Wall

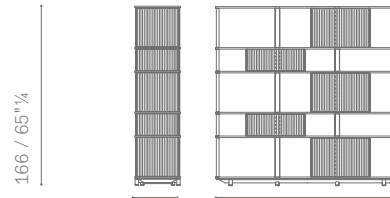

42,5 / 16"¾

170 / 67"

5607741

Freestanding

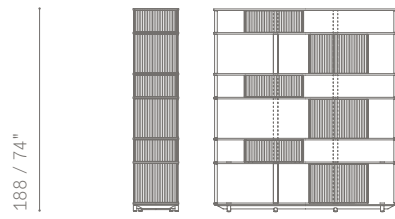

42,5 / 16"¾

170 / 67"

5607751

Wall

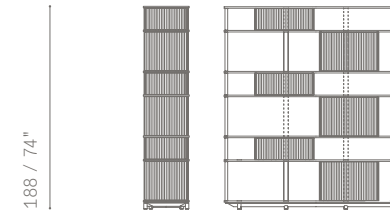

42,5 / 16"¾

170 / 67"

5607785

Freestanding

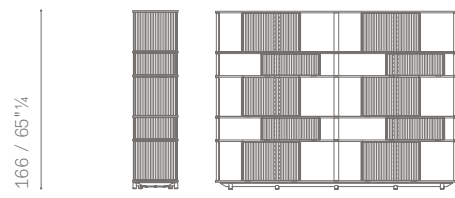

42,5 / 16"¾

225 / 88"½

5607795

Wall

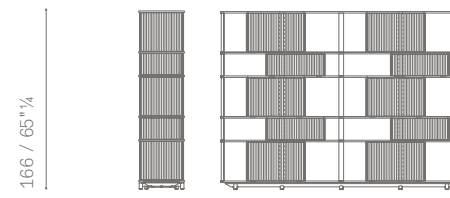

42,5 / 16"¾

225 / 88"½

5607786

Freestanding

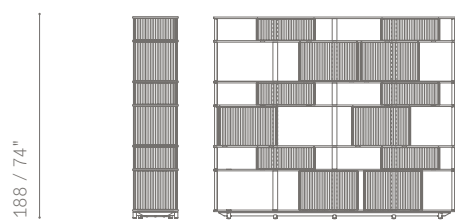

42,5 / 16"¾

225 / 88"½

5607796

Wall

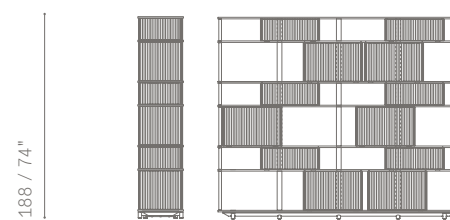

42,5 / 16"¾

225 / 88"½

## LLOYD - BOOKCASES

5607787  
Freestanding

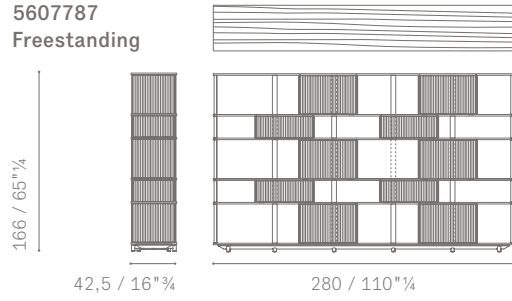

5607797  
Wall

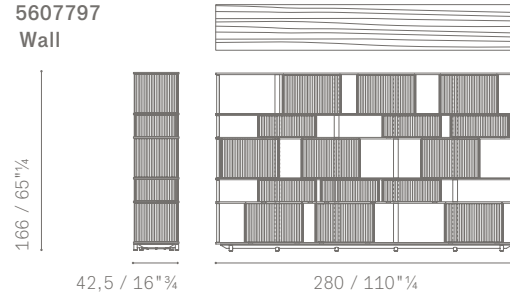

5607788  
Freestanding

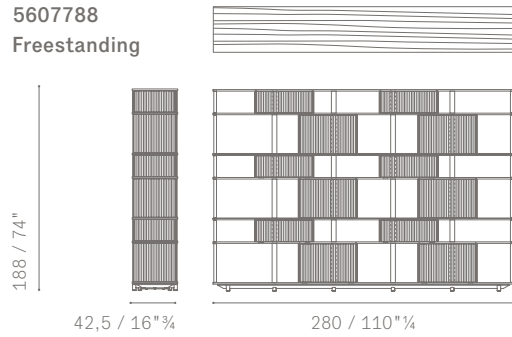

5607798  
Wall

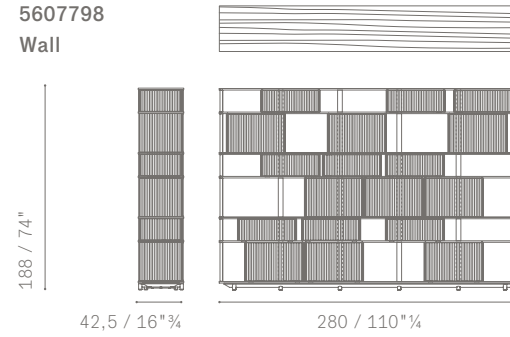

## OPTIONAL ACCESSORIES

### OPTIONAL SHELF

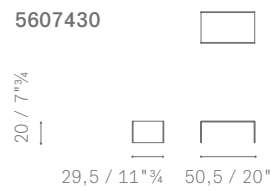

### OPTIONAL GRIDS

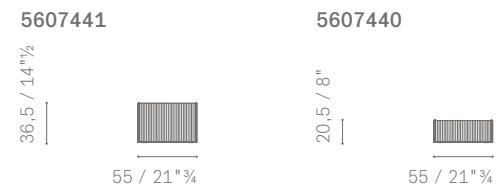

# SPECIFICHE TECNICHE / TECHNICAL SPECIFICATIONS

## VERSIONI, PORTATA E CAPIENZA / VERSIONS, MAXIMUM LOAD AND CAPACITY

### LOW CABINETS

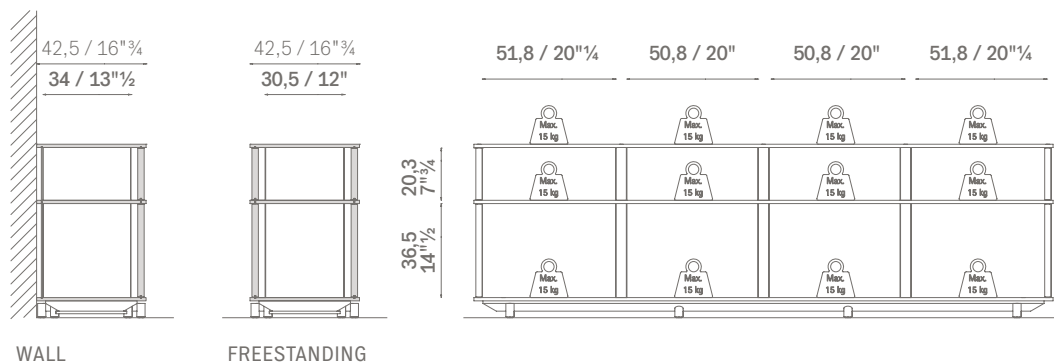

### HIGH CABINETS

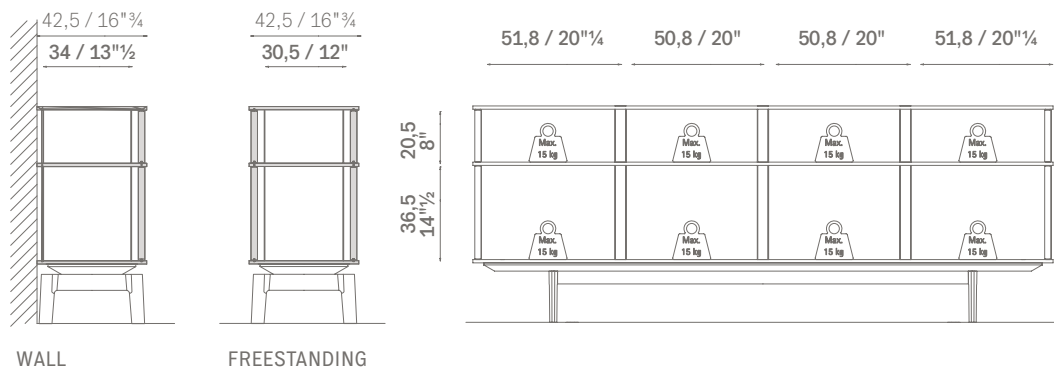

### BOOKCASES

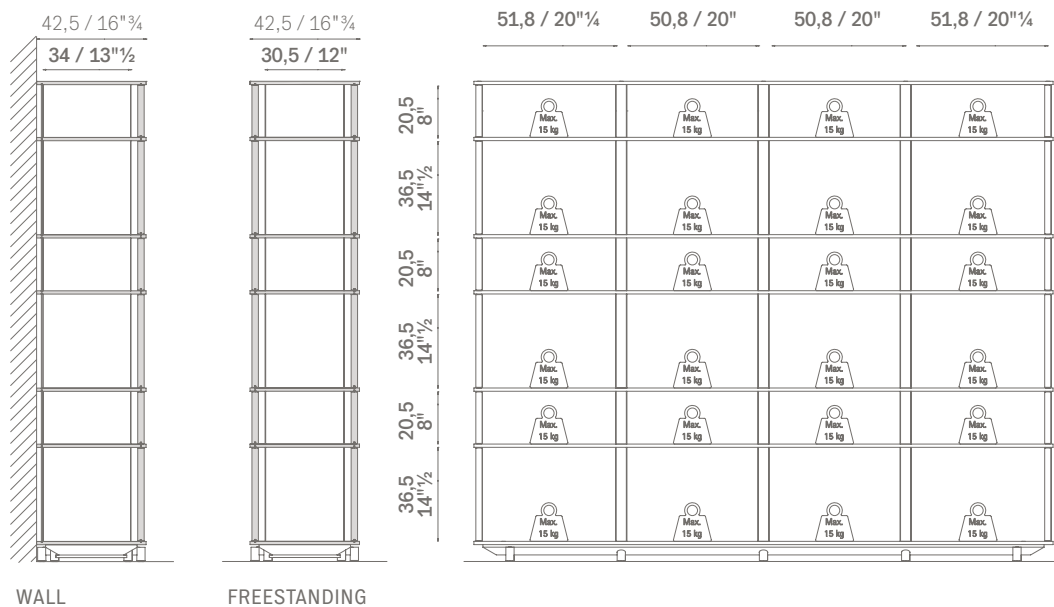

## SPECIFICHE TECNICHE / TECHNICAL SPECIFICATIONS

### PASSAGGIO CAVI / CABLE MANAGEMENT SYSTEM

#### ✕ POSIZIONAMENTO PASSACAVI / CABLE SYSTEM PLACEMENT

#### VISTA FRONTALE - FRONT VIEW

##### LOW CABINET 170×68 WALL

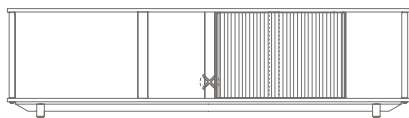

##### LOW CABINET 170×90 WALL

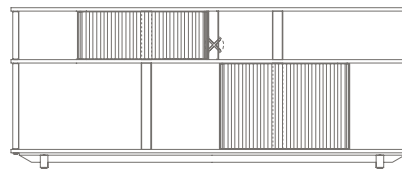

#### VISTA RETRO - REAR VIEW

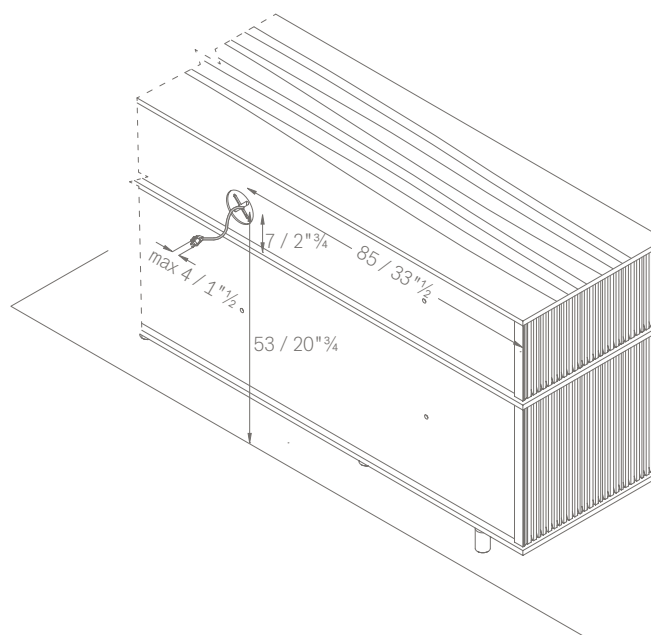
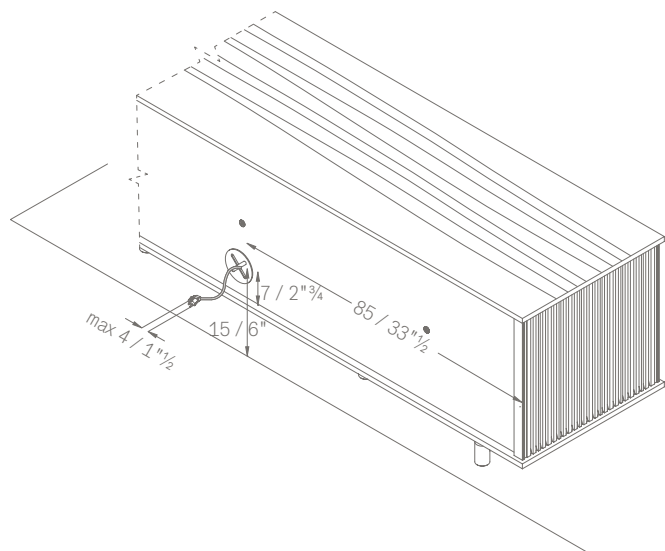

**SPECIFICHE TECNICHE / TECHNICAL SPECIFICATIONS**

**PASSAGGIO CAVI / CABLE MANAGEMENT SYSTEM**

**✕ POSIZIONAMENTO PASSACAVI / CABLE SYSTEM PLACEMENT**

**VISTA FRONTALE - FRONT VIEW**

**LOW CABINET 225×68 WALL**

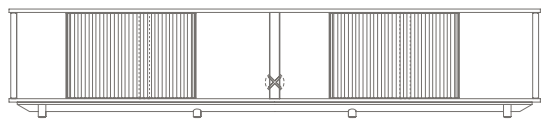

**LOW CABINET 225×90 WALL**

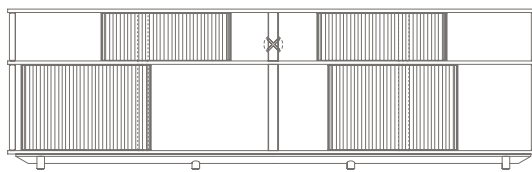

**LOW CABINET 280×68 WALL**

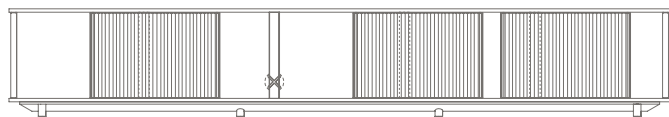

**LOW CABINET 280×90 WALL**

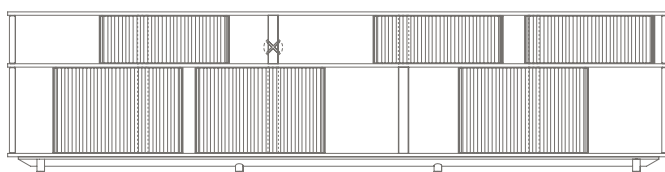

**VISTA RETRO - REAR VIEW**

