

# Lloyd Tex – Jean-Marie Massaud – 2022

---

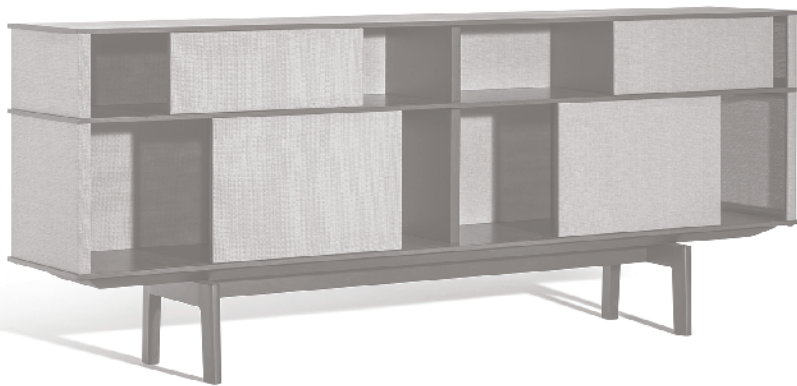

Ispirato dal mondo degli altoparlanti hi-fi, la libreria autoportante Lloyd Tex, design Jean-Marie Massaud, gioca sulla trasparenza e la leggerezza dei pannelli in Techno-fabric, un tessuto tecnico semi-trasparente nei colori Light e Dark. I pannelli scorrono sugli invisibili binari orizzontali, creando delle sequenze sempre diverse.

## CARATTERISTICHE TECNICHE

---

**Ripiani.** Realizzati in stratificato HPL impiallacciato in rovere naturale finitura piombo opaco (57).

**Montanti verticali.** Realizzati in fibra di legno a media densità impiallacciato in rovere naturale finitura piombo opaco (57).

**Fianchi.** Sono chiusi da pannelli fissi realizzati con un telaio in multistrato di betulla rivestito in tessuto tecnico. Il tessuto è disponibile in due varianti colore:  
- Techno-fabric Light  
- Techno-fabric Dark

**Pannelli scorrevoli.** Si muovono lungo binari intagliati nei ripiani e sono dotate di "pattini" in materiale plastico che diminuiscono l'attrito. Sono realizzati con un telaio in multistrato di betulla rivestito in tessuto tecnico. Il tessuto è disponibile in due varianti colore:  
- Techno-fabric Light  
- Techno-fabric Dark

### Varianti disponibili.

- "Freestanding": presenta pannelli scorrevoli su entrambi i lati (frontale e posteriore).
- "Wall": presenta pannelli scorrevoli solo sul lato frontale mentre il lato posteriore, a contatto con il muro, è chiuso con pannelli realizzati con un telaio in multistrato di betulla rivestito in tessuto tecnico. Il tessuto è in abbinamento a quello scelto per i fianchi e per i pannelli scorrevoli.

**Dettagli tecnici.** Viteria in acciaio con ghiera terminali a vista nichelate cromo opaco.

**Portata massima.** Non oltre i 15 Kg per ogni singolo vano.

## MODELLI LOW CABINET E BOOKCASE

---

**Piedi.** Realizzati in acciaio. Quelli esterni e in primo piano sono verniciati canna di fucile opaco mentre quelli centrali, più arretrati, sono laccati nero opaco.

## MODELLI HIGH CABINET

---

**Base a cavalletto.** In massello di rovere finitura piombo opaco (57).

## ACCESSORI E OPTIONAL

---

**Ripiano opzionale.** Autoportante e facilmente spostabile, è realizzato in alluminio e rivestito in cuoio Saddle Extra con bordi tagliati a vivo e rifiniti con tinta abbinata e cera protettiva.

Inspired by the world of hi-fi loudspeakers, the Lloyd Tex self-supporting bookcase, designed by Jean-Marie Massaud, plays with the transparency and lightness of the Techno-fabric panels, a semi-transparent technical fabric in Light and Dark colours. The panels slide on invisible horizontal tracks, creating ever-changing sequences.

## TECHNICAL FEATURES

---

**Shelves.** Made of high-pressure laminate in a natural oak veneer with a lead matte finish (57).

**Vertical uprights.** Made of MDF natural oak veneer with matt lead finish (57).

**Sides.** The sides are closed by fixed panels made with a birch plywood frame that are covered in technical fabric. The fabric is available in two colours:  
- Techno-fabric Light  
- Techno-fabric Dark

**Movable panels.** These slide along tracks carved into the shelves and feature plastic "skates" that reduce friction between the surfaces. They are made with a birch plywood frame covered in technical fabric. The fabric is available in two colour variants:  
- Techno-fabric Light  
- Techno-fabric Dark

### Available versions.

- "Freestanding": features movable panels on both the front and rear sides.
- "Wall": features movable panels only on the front, while the rear, which is in contact with the wall, is closed with panels made with a birch plywood frame covered in technical fabric. The fabric matches the one chosen for the sides and sliding panels.

**Technical details.** Steel screws with matt chrome nickel-plated terminal rings.

**Maximum load.** The weight must not exceed 15kg for each compartment.

## LOW CABINETS AND BOOKCASES

---

**Feet.** Made of steel, the external front feet feature a gunmetal grey matt finish, while the central ones, placed behind, are matt black lacquered.

## HIGH CABINETS

---

**Trestle-shaped base.** Solid oak wood with a lead matte finish (57).

## OPTIONAL ACCESSORIES

---

**Optional shelf.** Freestanding and easily movable, it is made of aluminium and covered with Saddle Extra saddle-leather. The clean-cut edges are dyed and finished with protective wax.

Per ogni modello della famiglia Lloyd è indicato un numero ideale di pannelli da inserire. E' tuttavia possibile scegliere una diversa configurazione secondo le esigenze del cliente.

An ideal number of panels to be inserted is indicated for each model of the Lloyd family. However, it is possible to choose a different configuration according to the customer's needs.

LLOYD TEX - LOW CABINETS

5607600  
Freestanding

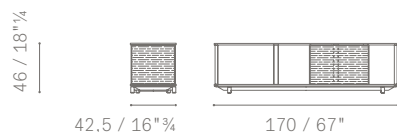

5607610  
Wall

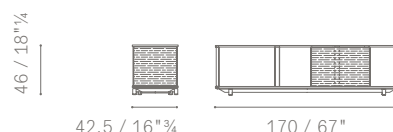

5607601  
Freestanding

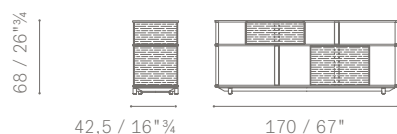

5607611  
Wall

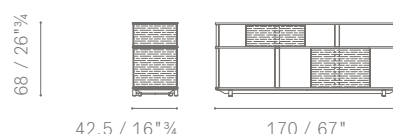

5607680  
Freestanding

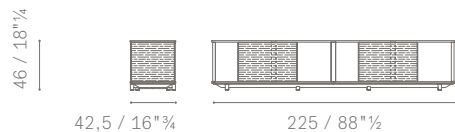

5607690  
Wall

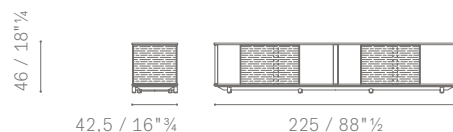

5607681  
Freestanding

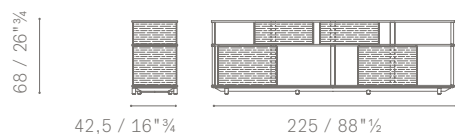

5607691  
Wall

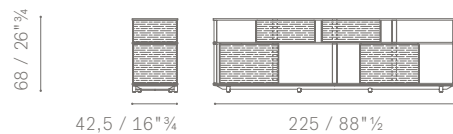

## LLOYD TEX - LOW CABINETS

5607682  
Freestanding

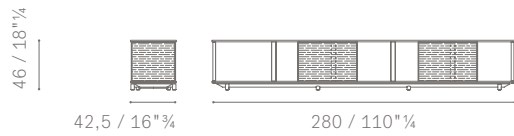

5607692  
Wall

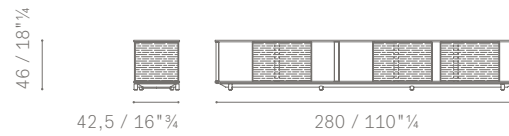

5607683  
Freestanding

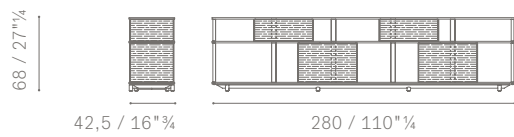

5607693  
Wall

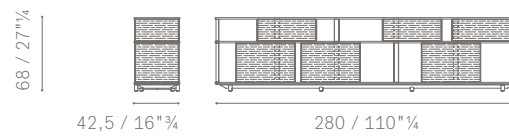

## LLOYD TEX - HIGH CABINETS

5607620  
Freestanding

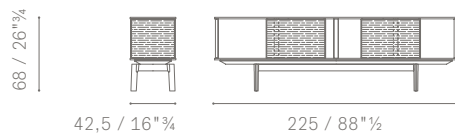

5607630  
Wall

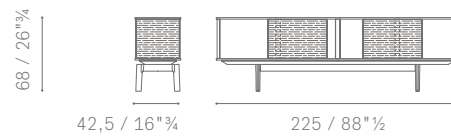

5607621  
Freestanding

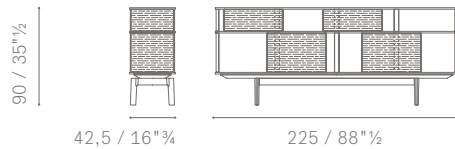

5607631  
Wall

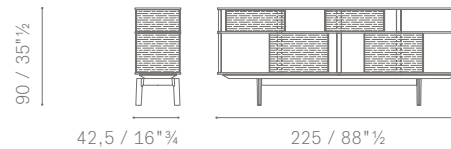

5607622  
Freestanding

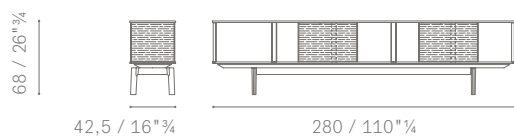

5607632  
Wall

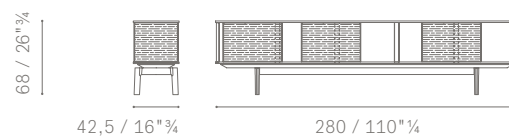

## LLOYD TEX - HIGH CABINETS

5607623  
Freestanding

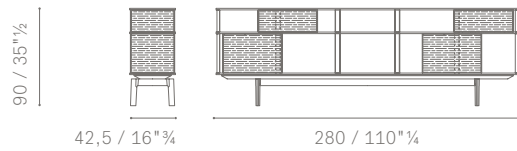

5607633  
Wall

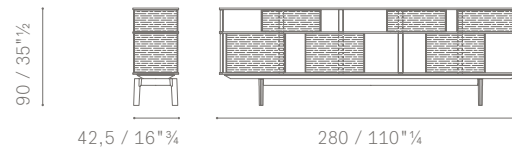

## LLOYD TEX - BOOKCASES

5607640  
Freestanding

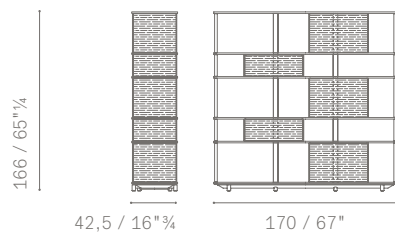

5607650  
Wall

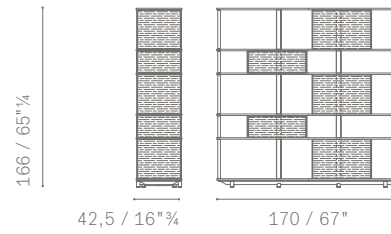
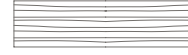

5607641  
Freestanding

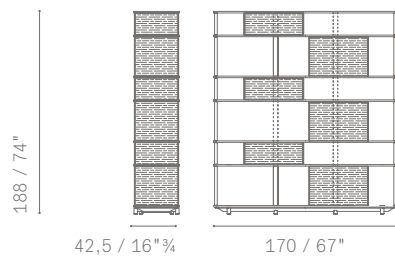

5607651  
Wall

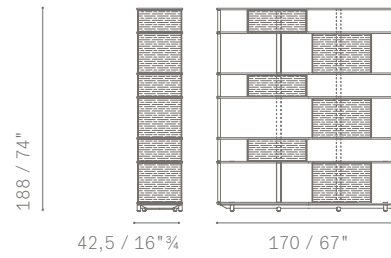

5607685  
Freestanding

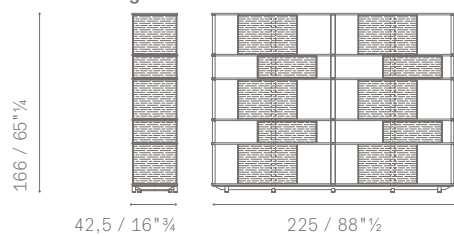

5607695  
Wall

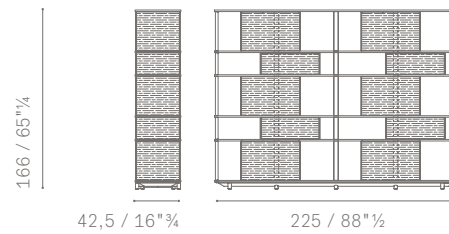

5607686  
Freestanding

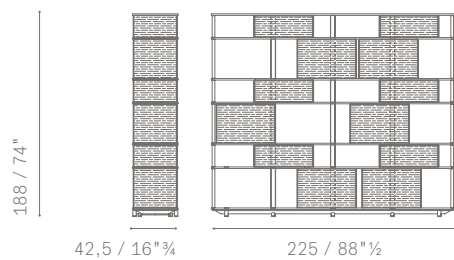

5607696  
Wall

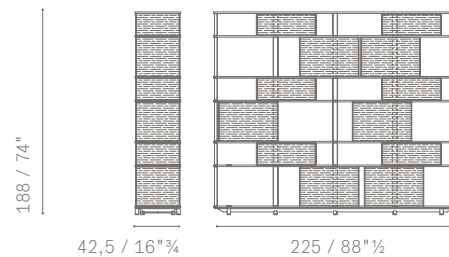

## LLOYD TEX - BOOKCASES

5607687  
Freestanding

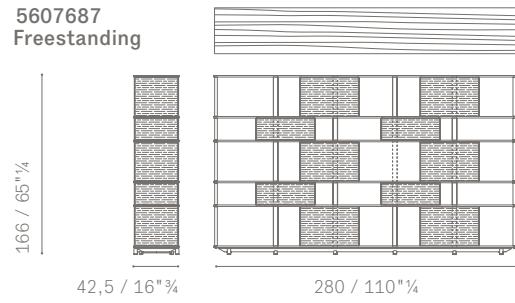

5607697  
Wall

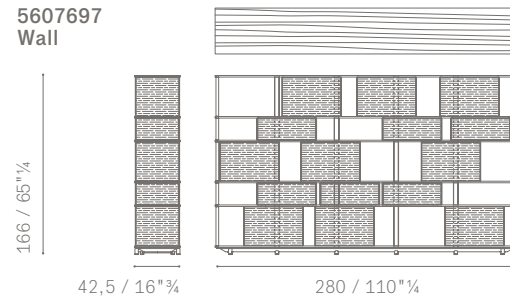

5607688  
Freestanding

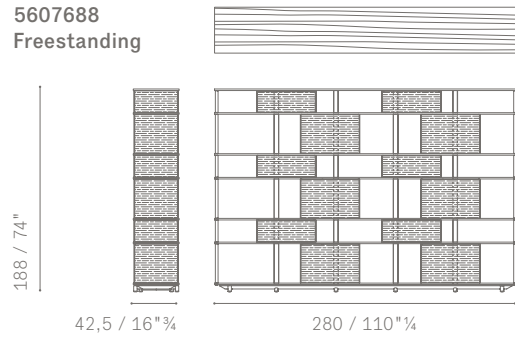

5607698  
Wall

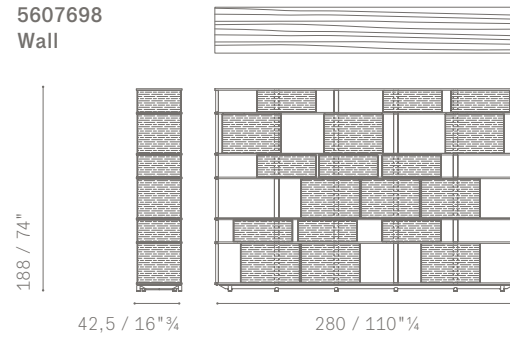

## OPTIONAL ACCESSORIES

### OPTIONAL SHELF

5607430

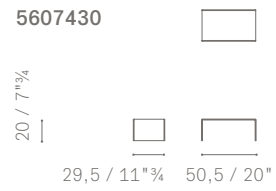

# SPECIFICHE TECNICHE / TECHNICAL SPECIFICATIONS

## VERSIONI, PORTATA E CAPIENZA / VERSIONS, MAXIMUM LOAD AND CAPACITY

### LOW CABINETS

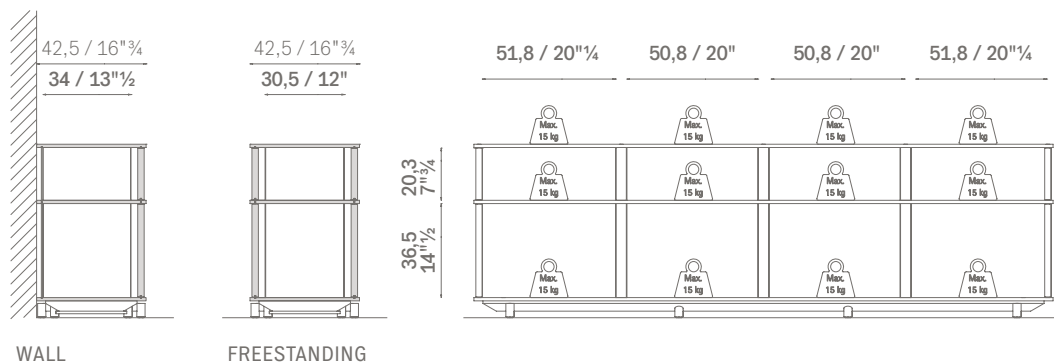

### HIGH CABINETS

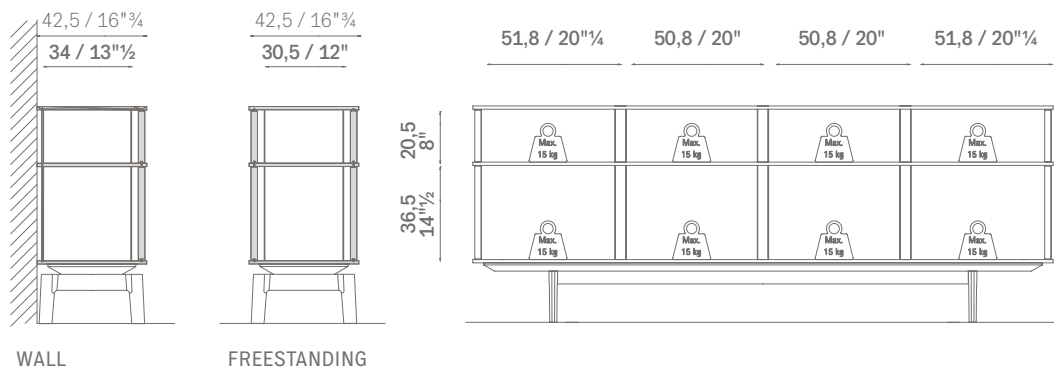

### BOOKCASES

